

Typ Model

MN-4500 series

Vícejehlové ramenové stroje

Multi needle machines

GARUDAN®

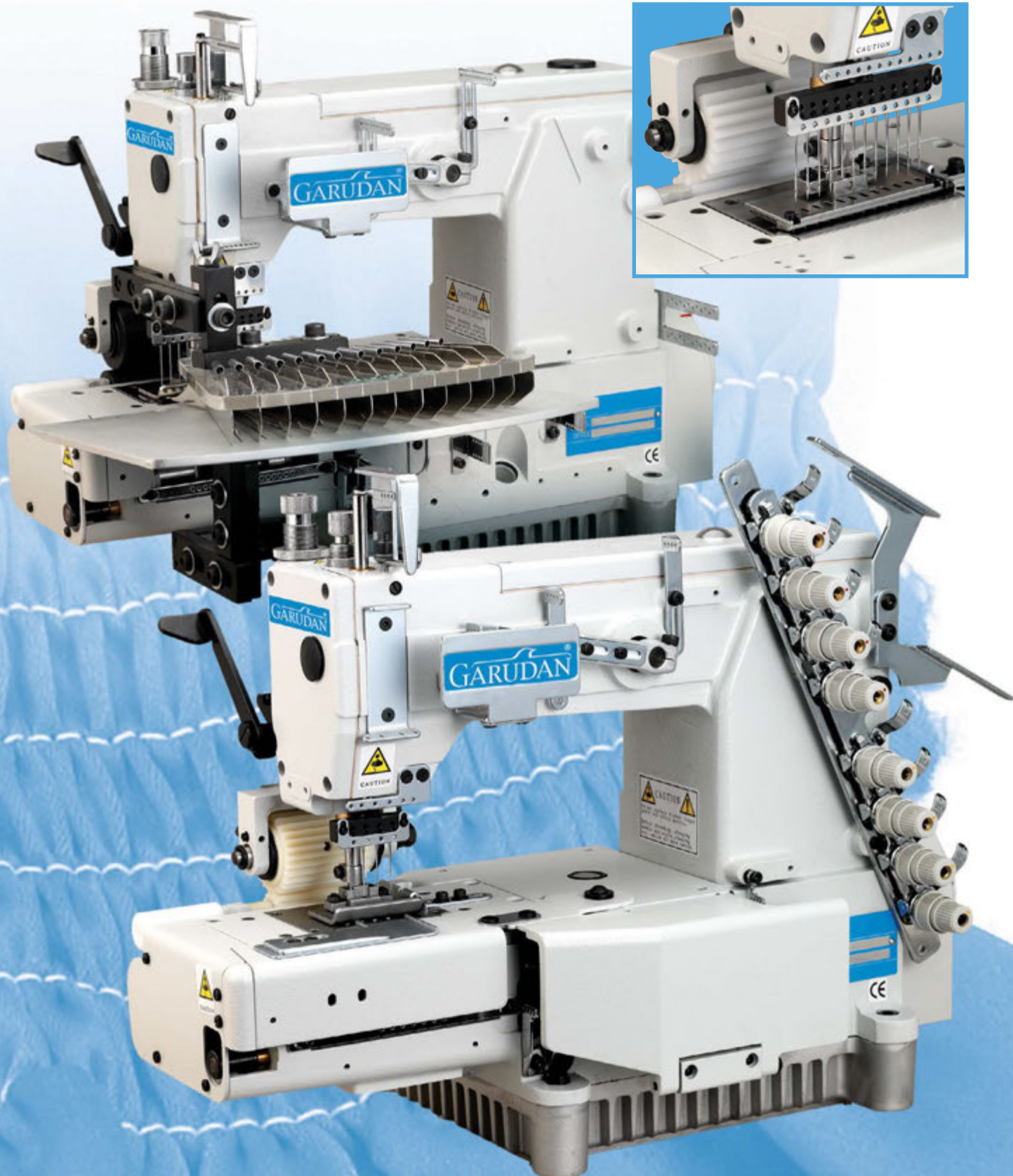
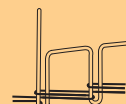



MODELOVÉ ZNAČENÍ

MODEL NUMBERING

MN-4504P □ - 064 □ / PMD

1 TYPOVÁ ŘADA:

MN: vícejehlové ramenové stroje

2 POČET JEHEL:

04: čtyřjehlové
06: šestijehlové
09: devítijehlové
12: dvanáctijehlové
13: třináctijehlové

3 ODTAHOVÝ VÁLEC

4 TYP ODTAHOVÉHO VÁLCE:

S: standardně je dodáván odtahový válec, horní 28 zubů, spodní 15 zubů
0: odtahový válec horní hladký, spodní hladký
1: odtahový válec horní 18 zubů, spodní 10 zubů
2: odtahový válec horní 22 zubů, spodní 12 zubů
3: odtahový válec horní ocelový – zubatý, spodní hladký



5 ROZTEČ JEHEL:

032: 3,2 mm
048: 4,8 mm
050: 5,0 mm
064: 6,4 mm
085: 8,5 mm
095: 9,5 mm
106: 10,6 mm
127: 12,7 mm

6 PODTŘÍDA:

A: kompenzační dělená patka (pouze u čtyřjehlových strojů když B = C = D)

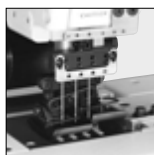

7 VOLITELNÉ PŘÍSLUŠENSTVÍ:

PMD: mechanické dávkování
FR401: zakladač pro šití gumy
:
(Detaily naleznete na dalších stránkách)

1 MODEL:

MN: Multi needle machines

2 NUMBER OF NEEDLES:

04: 4-Needle
06: 6-Needle
09: 9-Needle
12: 12-Needle
13: 13-Needle

3 REAR PULLER

4 TYPE OF PULLER:

S: Standard type: Upper roller 28 teeth, lower roller 15 teeth
0: Upper roller 0 teeth, lower roller 0 teeth
1: Upper roller 18 teeth, lower roller 10 teeth
2: Upper roller 22 teeth, lower roller 12 teeth
3: Upper steel roller with teeth, lower roller 0 teeth



5 NEEDLE DISTANCE:

032: 3,2 mm
048: 4,8 mm
050: 5,0 mm
064: 6,4 mm
085: 8,5 mm
095: 9,5 mm
106: 10,6 mm
127: 12,7 mm

6 SUB-CLASS:

A: Bisector presser foot (for 4-needle machines only if B = C = D)

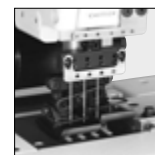

7 OPTIONAL DEVICE:

PMD: Lower feed metering device
FR401: Elastic hemming 2-folds
:
(Details at following pages)

CHARAKTERISTIKA

GENERAL FEATURES

- Maximální rychlost šití do 4500 stehů za minutu.
- Automatické tlakové mazání zaručuje dlouhou životnost stroje a dílců (obr. A a B).
- Patentovaný systém nitové páky redukuje přenos vibrací a možnost znečištění olejem.
- Jednoduché nastavení délky stehu (obr. C).
- Obvod ramene je 43 cm (včetně spodního odtahového válce, obr. D).
- Možnost měnit jednoduše rozpichy pomocí šicích sad.
- Široký rozsah přídatných aparátů.

- Maximum sewing speed up to 4500 stitches per minute.
- Automatic oiling system provides longer machine's and parts' life (pic. A and B).
- Patented thread take-up lever system reduces sewing vibration and prevents from oil leaking.
- Easy operated adjustment of stitch length (pic. C).
- Cylinder bed circumference is 43 cm (including the lower roller of rear puller, pic D).
- Different sewing requirements can be achieved by changing gauge sets.
- Large selection of various attachments.

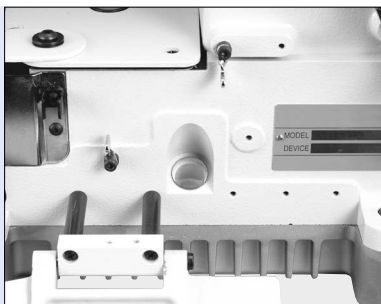

obr. A



obr. B

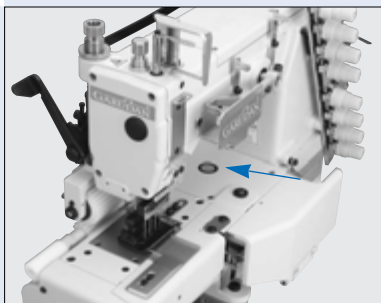

obr. C



obr. D

MN-4504P

ČTYŘJEHLVÉ OSMINITNÉ STROJE

4-NEEDLE, 8-THREAD MACHINE



MN-4504P



CHARAKTERISTIKA:

Tato řada strojů je standardně dodávána s odtahovým a napínacími válci a vodítkem, které je vhodné zejména pro šteповání gummy v pasovém límcu. Velké množství rozpichů umožňuje stroj použít i pro mnoho jiných šicích operací.

POUŽITÍ:

- Spodní prádlo, košile, kalhoty, pracovní oblečení, povlečení, závěsy, záclony atd.

VOLITELNÉ PŘÍSLUŠENSTVÍ:

- PMD – mechanické dávkování
- FR406 – vybavení pro našívání pásek

GENERAL FEATURES:









This series is supplied with rear puller, fabric tension controlling device and guide that is suitable for waistband elastic tape attaching. Large selection of various gauge sets enables many other sewing operations.

APPLICATION:

- Suitable for attaching elastic tape to the waist of trunks, boxers and similar garments.

OPTIONAL DEVICE:

- PMD – Lower feed metering device
- FR406 – Line stripes attaching device

			 (mm)	 (mm)	 (mm)	 UO x 113	 S.P.M.	AVAILABLE DEVICE
			A B C D					
MN-4504P-064(A)			19,2 6,4 6,4 6,4					
MN-4504P-085(A)			25,5 8,5 8,5 8,5					
MN-4504P-095(A)			28,5 9,5 9,5 9,5					
MN-4504P-106(A)			31,8 10,6 10,6 10,6					
MN-4504P-127(A)	4	8	38,1 12,7 12,7 12,7	1,6–3,6	8	75–90	4500	PMD FR406
MN-4504P-048-191			28,7 4,8 19,1 4,8					
MN-4504P-048-254			35,0 4,8 25,4 4,8					
MN-4504P-064-127			25,5 6,4 12,7 6,4					
MN-4504P-064-191			31,9 6,4 19,1 6,4					
MN-4504P-064-254			38,2 6,4 25,4 6,4					

MN-4506P

ŠESTIJEHLOVÉ DVANÁCTINITNÉ STROJE

6-NEEDLE, 12-THREAD MACHINE

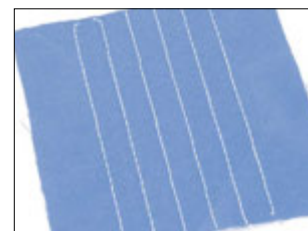

MN-4506P

CHARAKTERISTIKA:

Tato řada strojů je standardně dodávána s odtahovým válcem. Stroj lze objednat s rozpíchem jehel 6,4 mm, 8,5 mm a 9,5 mm. Doporučeným vybavením je FR406, které umožňuje našít až 3 pásy. Použitím jiných vybavení lze stroj použít i na další šicí operace.

POUŽITÍ:

- Kalhoty, pracovní oblečení, bundy atd.

VOLITELNÉ PŘÍSLUŠENSTVÍ:

- PMD – mechanické dávkování
- FR406 – vybavení pro našívání pásek

GENERAL FEATURES:







This series is supplied with rear puller and can be ordered with 6,4 mm, 8,5 mm or 9,5 mm gauge sets. Suggested device is FR406 that enables to attach up to 3 tapes. Machine can be used for other sewing operations by using other devices.

APPLICATION:

- Suitable for attaching elastic tape to the waist of trunks, boxers and similar garments.

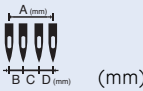
OPTIONAL DEVICE:

- PMD – Lower feed metering device
- FR406 – Line stripes attaching device

			 (mm)	 (mm)	 (mm)	 UO x 113	 S.P.M.	AVAILABLE DEVICE
MN-4506P-064			A B 32,0 6,4					
MN-4506P-085	6	12	42,5 8,5	1,6–3,6	8	75–90	4500	PMD FR406
MN-4506P-095			47,5 9,5					

MN-4509P

DEVÍTIJEHLOVÉ OSMNÁCTINITNÉ STROJE

9-NEEDLE, 18-THREAD MACHINE

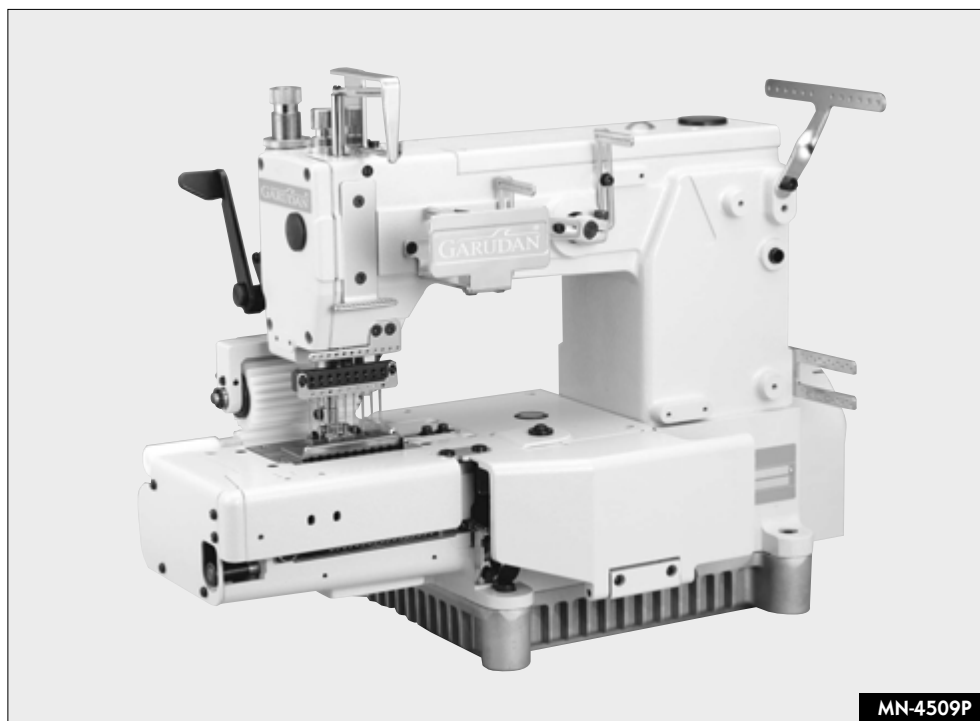

MN-4509P



CHARAKTERISTIKA:

Tato řada strojů je standardně dodávána s odtahovým válcem. Stroj se standardně dodává s rozpichem jehel 6,4 mm. Celková rozteč mezi krajními jehlami je tedy 51,2 mm. Doporučeným vybavením je FR406, které umožňuje našít až 4 pásky. Použitím jiných vybavení lze stroj použít i na další šicí operace.

POUŽITÍ:

- Kalhoty, pracovní oblečení, bundy atd.

VOLITELNÉ PŘÍSLUŠENSTVÍ:

- PMD – mechanické dávkování
- FR406 – vybavení pro našívání pásek

GENERAL FEATURES:









This series is supplied with rear puller and standardly supplied with 6,4 mm gauge set. Total needle distance between outer needles is 51,2 mm. Suggested device is FR406 that enables to attach up to 4 tapes. Machine can be used for other sewing operations by using other devices.

APPLICATION:

- Suitable for various applications, such as trunks, sports pants.

OPTIONAL DEVICE:

- PMD – Lower feed metering device
- FR406 – Line stripes attaching device

			 (mm)	 (mm)	 (mm)	 UO x 113	 S.P.M.	AVAILABLE DEVICE
MN-4509P-064	9	18	A = 51,2 B = 6,4	1,6–3,6	8	75–90	4500	PMD, FR406

MN-4512P



DVANÁCTIJEHLOVÉ DVACETIČTYŘNITNÉ STROJE

12-NEEDLE, 24-THREAD MACHINE



CHARAKTERISTIKA:

Tato řada strojů je standardně dodávána s odtahovým válcem. Lze ji dodat se třemi druhy rozpichů.

Maximální celková rozteč mezi krajními jehlami je tedy:

- 52,8 mm při rozteči 4,8 mm
- 55,0 mm při rozteči jehel 5,0 mm
- 70,4 mm při rozteči jehel 6,4 mm.

POUŽITÍ:

- Spodní prádlo, košile, kalhoty, pracovní oblečení, povlečení, závěsy, záclony atd.

VOLITELNÉ PŘÍSLUŠENSTVÍ:

- PMD – mechanické dávkování
- FR406 – vybavení pro našívání pásek
- PS001 – vybavení pro šití pružnou nití (gumičkou)řasení
- PT001 – vybavení „tuxedo“ (šití sklady)

GENERAL FEATURES:

This series is supplied with rear puller and standardly supplied with three different gauge sets. Total needle distance between outer needles is as follows:

- 52,8 mm (4,8 mm needle distance)
- 55,0 mm (5,0 mm needle distance)
- 70,4 mm (6,4 mm needle distance)

APPLICATION:

- Suitable for various applications, such as trunks, sports pants.

OPTIONAL DEVICE:

- PMD – Lower feed metering device
- FR406 – Line stripes attaching device
- PS001 – Elastic thread shirring
- PT001 – Pin tucking

								AVAILABLE DEVICE
			(mm)	(mm)	(mm)	UO x 113	S.P.M.	
MN-4512P-048			A = 52,8 B = 4,8					PMD
MN-4512P-050	12	24	A = 55,0 B = 5,0	1,6–3,6	8	75–90	4500	FR406 PT001
MN-4512P-064			A = 70,4 B = 6,4					PS001

MN-4513P



TŘINÁCTIJEHLOVÉ DVACETIŠESTINITNÉ STROJE

13-NEEDLE, 26-THREAD MACHINE

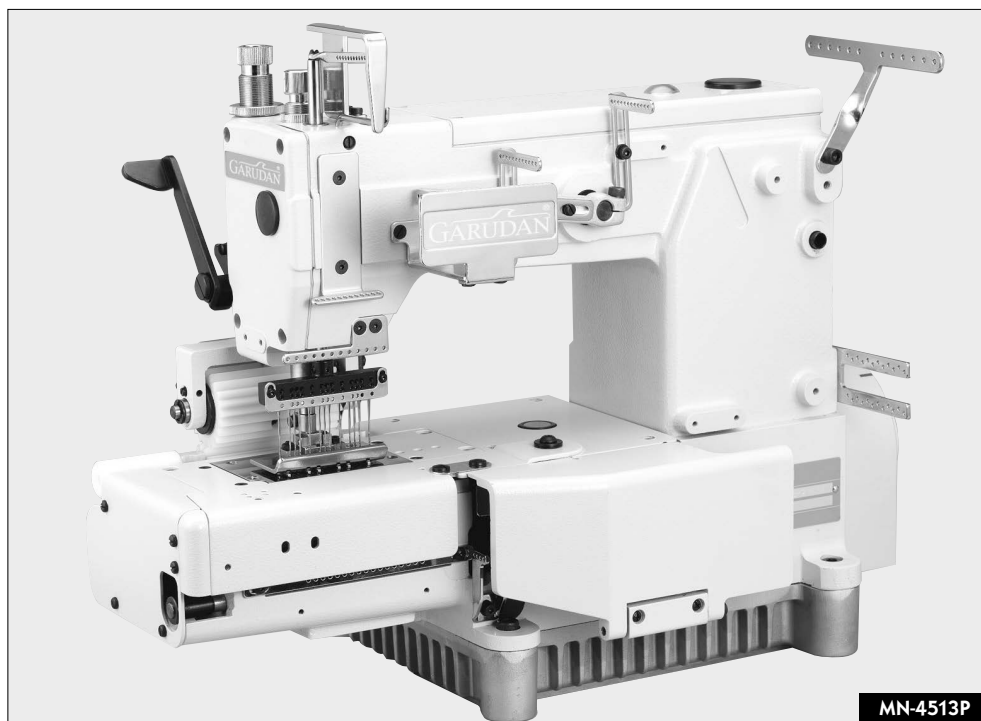

MN-4513P

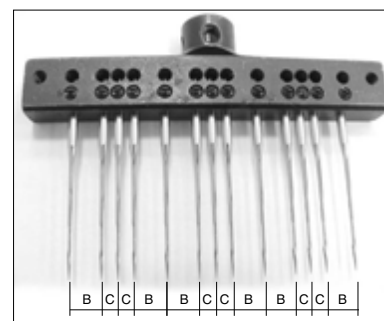
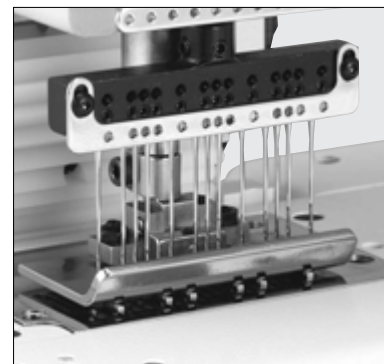

CHARAKTERISTIKA:

Tento multifunkční stroj se standardně dodává s jehelníkem s rozpichem 6,4 mm. Může být vybaven speciálním jehelníkem (viz foto), který umožňuje multifunkční šití bez nutnosti výměny šicí sady. Stroj je standardně dodáván s odtahovým válcem.

Maximální celková rozteč mezi krajními jehlami je 76,8 mm nebo 57,6 mm.

POUŽITÍ:

- Spodní prádlo, košile, kalhoty, pracovní oblečení, povlečení, závěsy, záclony atd.

VOLITELNÉ PŘÍSLUŠENSTVÍ:

- PMD – mechanické dávkování
- FR406 – vybavení pro našívání pásků

GENERAL FEATURES:

This multi-function machine can be equipped with special needle clamp that enables to sew with three different maximum needle distances without changing needle gauges. This series is supplied with rear puller.









Total needle distance between outer needles is 76,8 mm or 57,6 mm.

APPLICATION:

- Suitable for various applications, such as trunks, sports pants.

OPTIONAL DEVICE:

- PMD – Lower feed metering device
- FR406 – Line stripes attaching device

			 (mm)	 (mm)	 (mm)	 UO x 113	 S.P.M.	AVAILABLE DEVICE
MN-4513P-064 MN-4513P-064-032	13	26	A = 76,8 B = 6,4 A = 57,6 B = 6,4 C = 3,2	1,6–3,6	8	75–90	4500	PMD FR406

MN PMD



MECHANICKÉ SPODNÍ DÁVKOVÁNÍ GUMIČKY

ELASTIC TAPE INSERTING ATTACHING

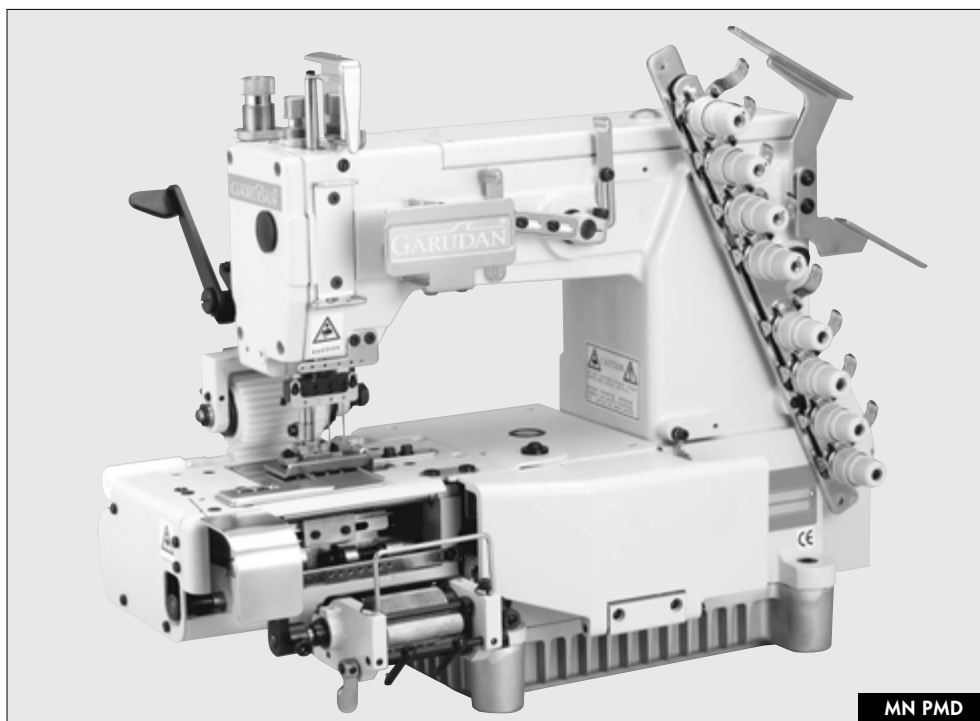

MN PMD

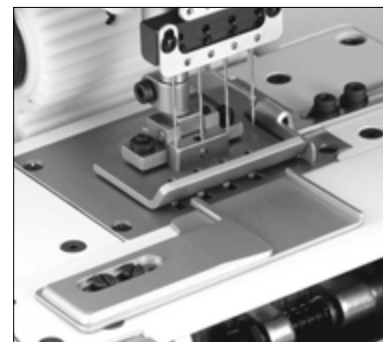

CHARAKTERISTIKA:

Tato řada strojů je standardně dodávána s odtahovým válcem a mechanickým dávkováním gumičky. Doporučeným vybavením je FR405 nebo SF. Použitím jiných vybavení lze stroj použít i na další šicí operace.

POUŽITÍ:

- Všívání gumy do pasového límce. Kalhoty, pracovní oblečení, bundy atd.







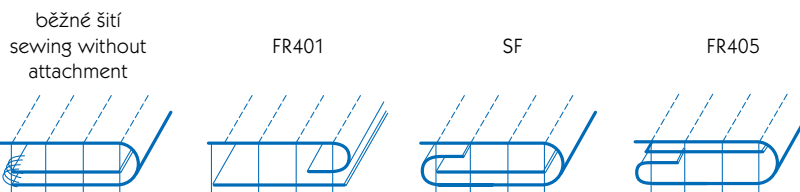

GENERAL FEATURES:

This series is supplied with rear puller and elastic tape inserting attaching. Suggested device is FR405 or SF. Machine can be used for other sewing operations by using other devices.

APPLICATION:

- Suitable for attaching elastic waistband to trunks or boxers, sports pants etc.



			 (mm)	 (mm)	 (mm)	 UO x 113	 S.P.M.	AVAILABLE DEVICE
MN-4504P-xxx/PMD	4	8	Mohou být použity	1,6–3,6	8	75–90	4000	FR401 FR405 SF
MN-4506P-xxx/PMD	6	12	všechny standardní					
MN-4509P-xxx/PMD	9	18	rozpichy.					
MN-4512P-xxx/PMD	12	24	All standard needle					
MN-4513P-xxx/PMD	13	26	gauges can be used.					

MN PS001

ŠITÍ PRUŽNOU NITÍ (GUMIČKOU) – ŘASENÍ

ELASTIC THREAD SHIRRING

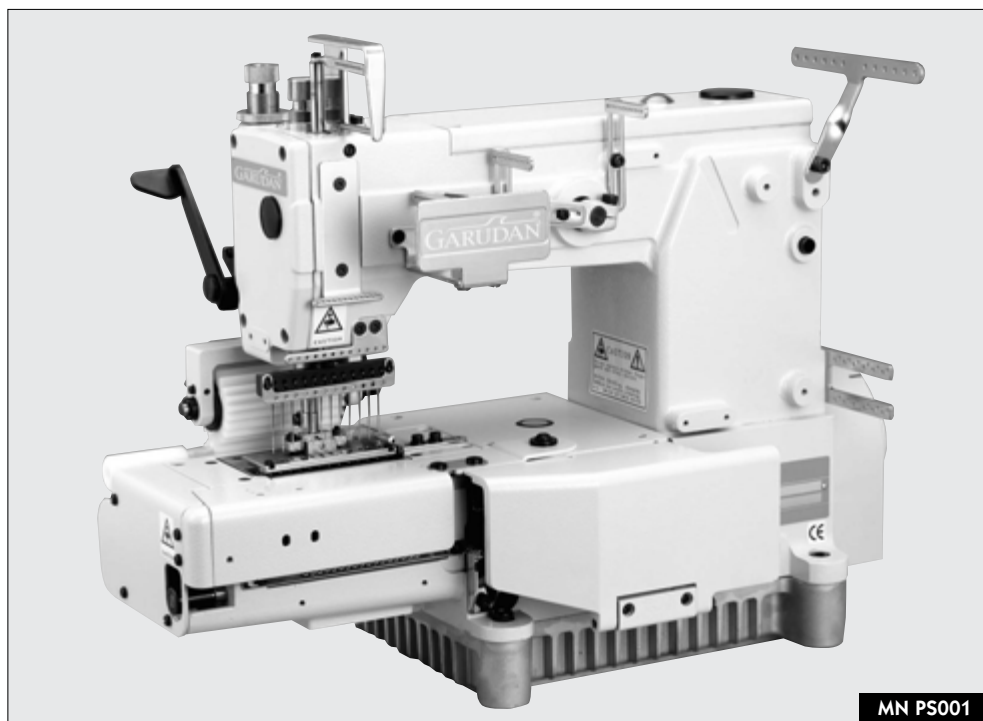

MN PS001



CHARAKTERISTIKA:

Tato řada strojů se dodává pouze ve 12-ti jehlovém provedení. Stroj je standardně vybaven hladkým polyurethanovým odtahovým válcem. Místo spodních nití se používá nit pružná, která výrobek „stáhne“, šev zůstává pružný.

POUŽITÍ:

- Ozdobné pružné našasení







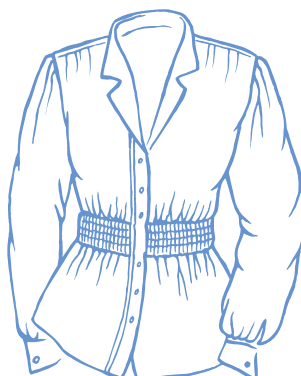

GENERAL FEATURES:

This series is supplied with 12-needle version with 0-teeth polyurethan rear puller. Machines use elastic threads instead of standard bottom threads. This enables to achieve elastic seam.

POUŽITÍ:

- Suitable for ladies fashion wear.



			 (mm)	 (mm)	 (mm)	 UO x 113	 S.P.M.	AVAILABLE DEVICE
MN-4512P0-048/PS001 MN-4512P0-064/PS001	12	24	A = 52,8 B = 4,8 A = 70,4 B = 6,4	1,6–3,6	8	75–90	4000	

MN PT001

ŠITÍ SKLADŮ
PIN TUCKING

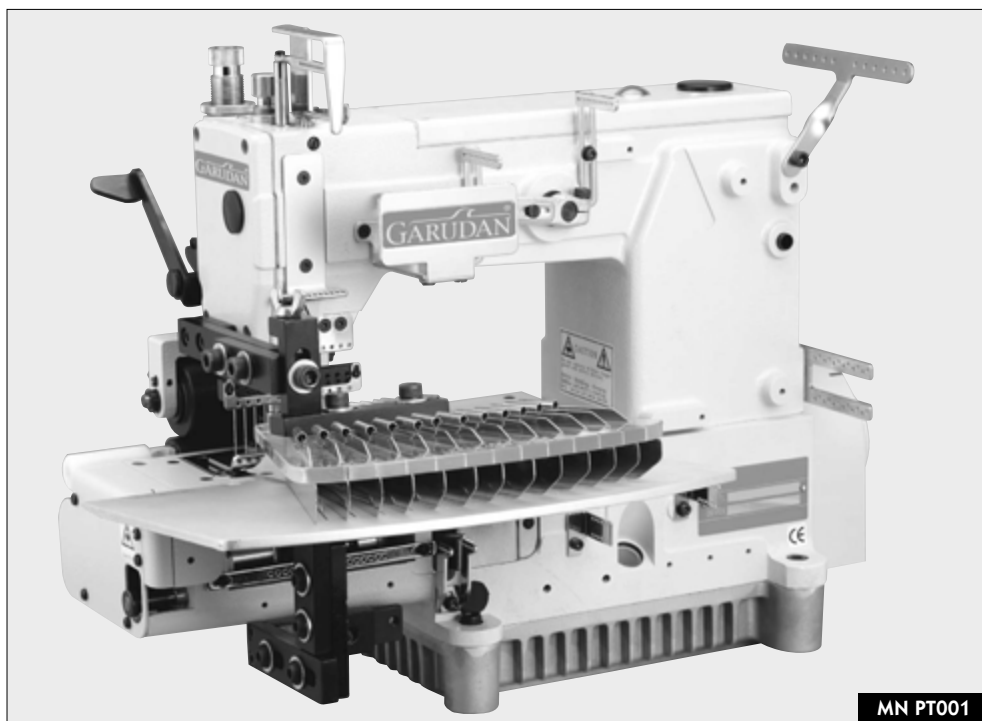

MN PT001

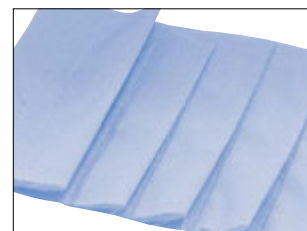

CHARAKTERISTIKA:

Tato řada strojů se dodává pouze ve 12-ti jehlovém provedení. Stroj je standardně vybaven hladkým polyurethanovým odtahovým válcem. Speciální aparát vytvoří záhyby, které jsou následovně zašity.

POUŽITÍ:

- Tzv. „tuxedo“ ozdobné šití na pánských košilích, nebo dámských halenkách.









GENERAL FEATURES:

This series is supplied with 12-needle version with 0-teeth polyurethan rear puller. Special device makes bends that are subsequently seamed.

APPLICATION:

- Suitable for men's tuxedo shirts etc.



			 (mm)	 (mm)	 (mm)	 UO x 113	 S.P.M.	AVAILABLE DEVICE
MN-4512P0-048/PT001 MN-4512P0-064/PT001	12	24	A = 52,8 B = 4,8 A = 70,4 B = 6,4	1,6–3,6	8	75–90	2500	

MN FR406



NAŠÍVÁNÍ OZDOBNÝCH PÁSKŮ

LINE STRIPES ATTACHING

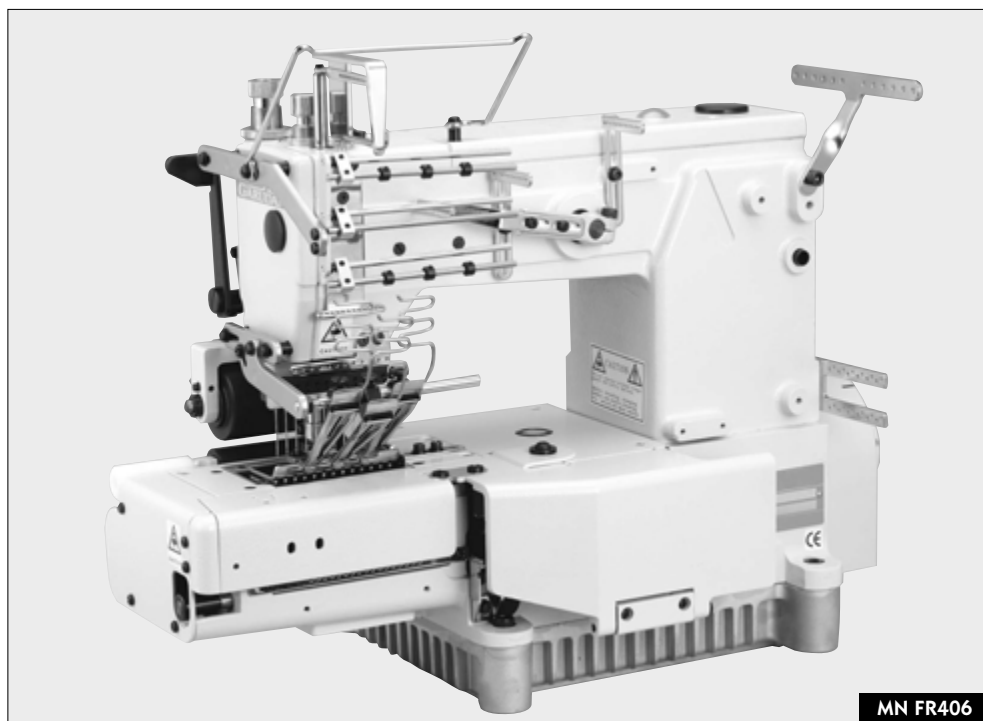

MN FR406



CHARAKTERISTIKA:

Tato řada strojů se dodává pouze ve 12-ti jehlovém provedení. Stroj je standardně vybaven hladkým polyurethanovým odtahovým válcem.

POUŽITÍ:

- Sportovní kalhoty, bundy apod.







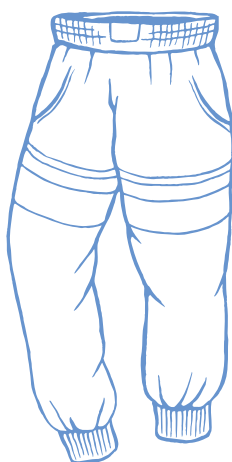

GENERAL FEATURES:

This series is supplied with 12-needle version with 0-teeth polyurethan rear puller.

APPLICATION:

- Suitable for various applications, such as trunks, sports pants.



			 (mm)	 (mm)	 (mm)	 UO x 113	 S.P.M.	AVAILABLE DEVICE
MN-4512P0-048/FR406 MN-4512P0-064/FR406	12	24	A = 52,8 B = 4,8 A = 70,4 B = 6,4	1,6-3,6	8	75-90	4000	

VOLITELNÉ PŘÍSLUŠENSTVÍ
PMD
OPTIONAL DEVICE

MECHANICKÉ DÁVKOVÁNÍ GUMY
LOWER FEED METERING DEVICE

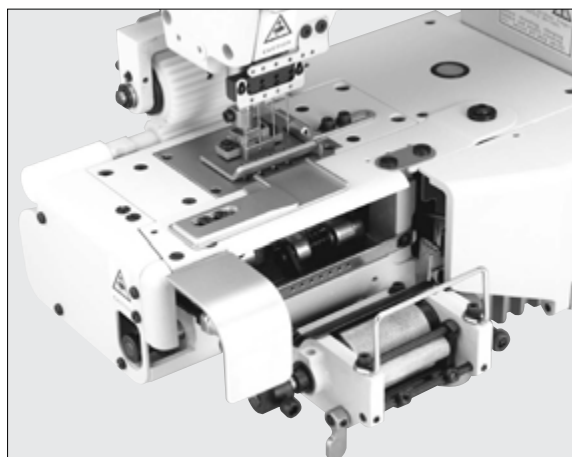

- Zajišťuje přesné dávkování gumy při jejím všívání do pasového límce.
- Lower feed metering device.



Možnosti všívání gumy:
Application:



VOLITELNÉ PŘÍSLUŠENSTVÍ
FR401
OPTIONAL DEVICE

ZAKLADAČ PRO ŠITÍ GUMY DO PASU (OTEVŘENÉ PŘÍKROVĚNÍ)
ELASTIC HEMMING – 2 FOLDS

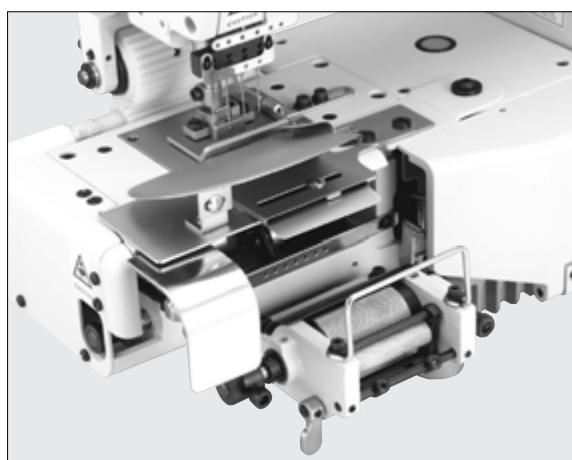

- Zajišťuje podehnutí materiálu a jeho našití na pod ním vedenou gumičku. (Max. šíře gumy je 40 mm)
- Elastic hemming – 2 folds.

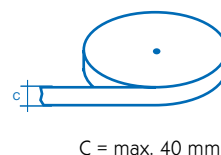
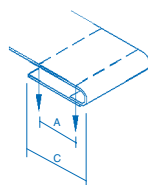

VOLITELNÉ PŘÍSLUŠENSTVÍ
FR402
OPTIONAL DEVICE

ZAKLADAČ PRO ŠITÍ PASOVÉHO LÍMCE (PŘÍMÉ ŠITÍ)
TOP AND BOTTOM WAISTBAND ATTACHMENT

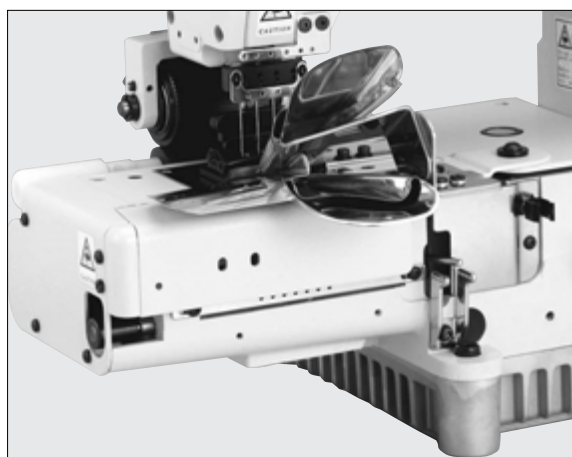

- Zajišťuje založení 2 pásků např. při šití předního dílu košil, prac. oblečení atd.
- Top and bottom waistband attachment.

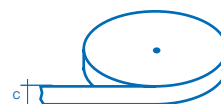
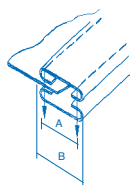

A (mm)	B (mm)	C (mm)
38,1	42	65
31,8	35	56

VOLITELNÉ PŘÍSLUŠENSTVÍ
FR403
OPTIONAL DEVICE

ZAKLADAČ PRO ŠITÍ PASOVÉHO LÍMCE (TVAROVÉ ŠITÍ)

TOP AND BOTTOM WAISTBAND ATTACHING



- Zajišťuje založení 2 pásků, případně šití pásku límce (tvarové šití).
- Top and bottom waistband attaching.

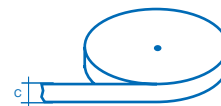
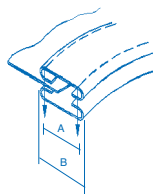

A (mm)	B (mm)	C (mm)
38,1	42	65
31,8	35	56

VOLITELNÉ PŘÍSLUŠENSTVÍ
FR404
OPTIONAL DEVICE

LEMOVAČ PRO ŠITÍ PASOVÉHO LÍMCE

CURVE WAISTBAND ATTACHING

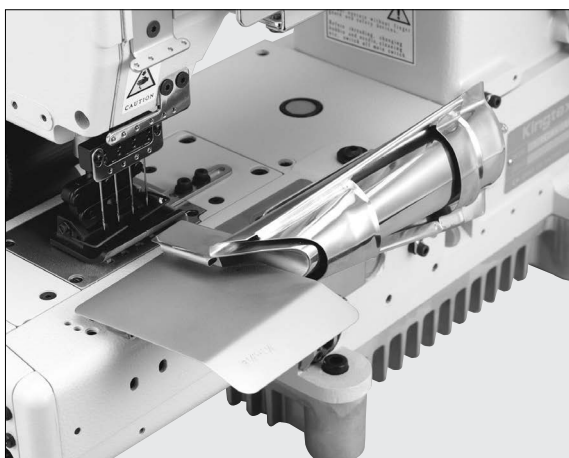

- Zajišťuje založení pásového límce.
- Curve waistband attaching.

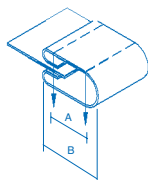

A (mm)	B (mm)	C (mm)
38,1	42	110
31,8	35	95
25,4	30	85

VOLITELNÉ PŘÍSLUŠENSTVÍ
FR405
OPTIONAL DEVICE

ZAKLADAČ PRO ŠITÍ GUMY DO PASU (UZAVŘENÉ PŘÍKRYTÍ)

ELASTIC HEMMING – 3 FOLDS



- Zajišťuje založení materiálu a uložení gumy do vytvořeného tunýlku.
- Elastic hemming – 3 folds.

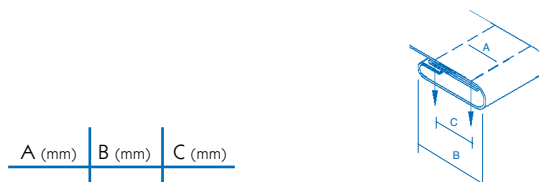

A (mm)	B (mm)	C (mm)
28,5	33	31
25,4	30	28
38,1	42	40
19,1	25	23
31,8	35	34

VOLITELNÉ PŘÍSLUŠENSTVÍ
FR406
OPTIONAL DEVICE

 **NAŠÍVÁNÍ OZDOBNÉ PÁSKY**
 **LINE STRIPES ATTACHING**



- Zajišťuje založení ozdobných pásků.
- Line stripes attaching.

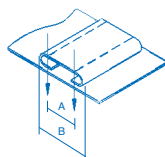

A (mm)	B (mm)	C (mm)
4,8	8	16
6,4	9,5	19

VOLITELNÉ PŘÍSLUŠENSTVÍ
SF
OPTIONAL DEVICE

 **SPIRÁLOVÝ ZAKLADAČ**
 **SPIRAL FOLDER**

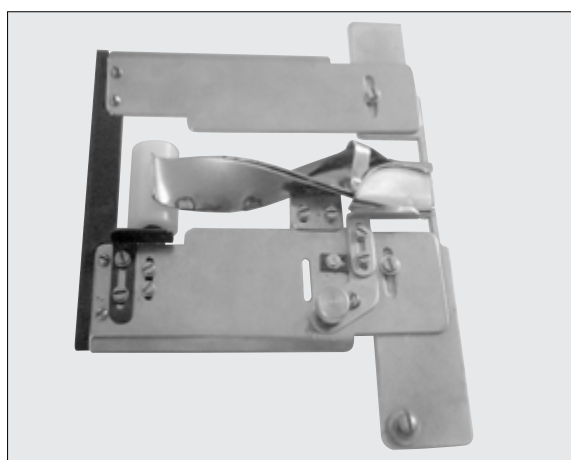

- Komfortní šití pásového límce, kdy je guma obalena materiálem.
- Comfortable waistband sewing, elastic tape is covered by material.

A (mm)	B (mm)	C (mm)
28,5	33	31
25,4	30	28
38,1	42	40
19,1	25	23
31,8	35	34

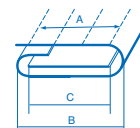

A series of horizontal dotted lines for writing, organized into two columns.

A series of horizontal dotted lines for writing, organized into two columns.



Typ Model

MN-4500 series

Vícejehlové ramenové stroje

Multi needle machines

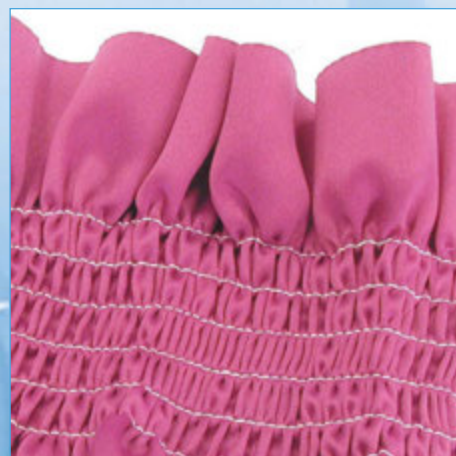

ANITA B s.r.o.
Hliníky 2068
680 01 Boskovice
Czech Republic
tel.: +420 516 454 774, 516 453 496
fax: +420 516 452 751
e-mail: info@anita.cz
www.garudan.cz

Změna vzhledu a parametrů vyhrazena. Changes in outer appearance and in parameters are reserved.

LF00034 CZ/EN 02/2018